

JF4.8AI

Image Size: $\frac{2}{3}$ $\frac{1}{2}$ $\frac{1}{3}$ $\frac{1}{4}$

[SPECIFICATIONS]

Focal Length :	4.8mm	Input Impedance :	High Impedance
Maximum Relative Aperture :	1:1.8	Operation :	Focus : Manual
Iris :	F1.8 - Approx. 360 (With ND Spot Filter)	Iris :	EE (DC+8 to 16V : Fixed Voltage, Max40mA) Speed Within 4sec.(Auto Close System)
Sensitivity Adjustment :	0.5 - 1Vp-p(Image Signal)	EE Mechanism :	The built-in EE Amp amplifies the difference between the video signal from the camera and the preset Iris signal level. It causes the Iris to change size.
Angular Field of View :	85.0 X69.0 deg.	EE Accuracy :	With Input Video Signal 0.7Vp-p Within +/-10% of Mean Value
Image Format :	8.8X6.6mm(D11mm)	Operation Temperature :	-10 to +50
Minimum Object Distance :	0.2m(From Front Vertex)	Mount :	C-Mount(Adjustable Lens Position)
Object Dimensions at M.O.D. :	39.4X29.6cm	Front Thread :	43mm P0.75
Optical Back Focal Distance :	10.86mm(In Air)	Size, Weight :	59.5X50X37.5mm, Approx. 95g
Flange Back :	17.526mm		
Input Signal :	Composite Video Signal or Video Signal		
Photometry Range :	40% - 70% Variable to Vp-p		

[COMPOSITION]

- Lens1
- Lens Cap1
- Dust Cap1

[DIMENSIONS]

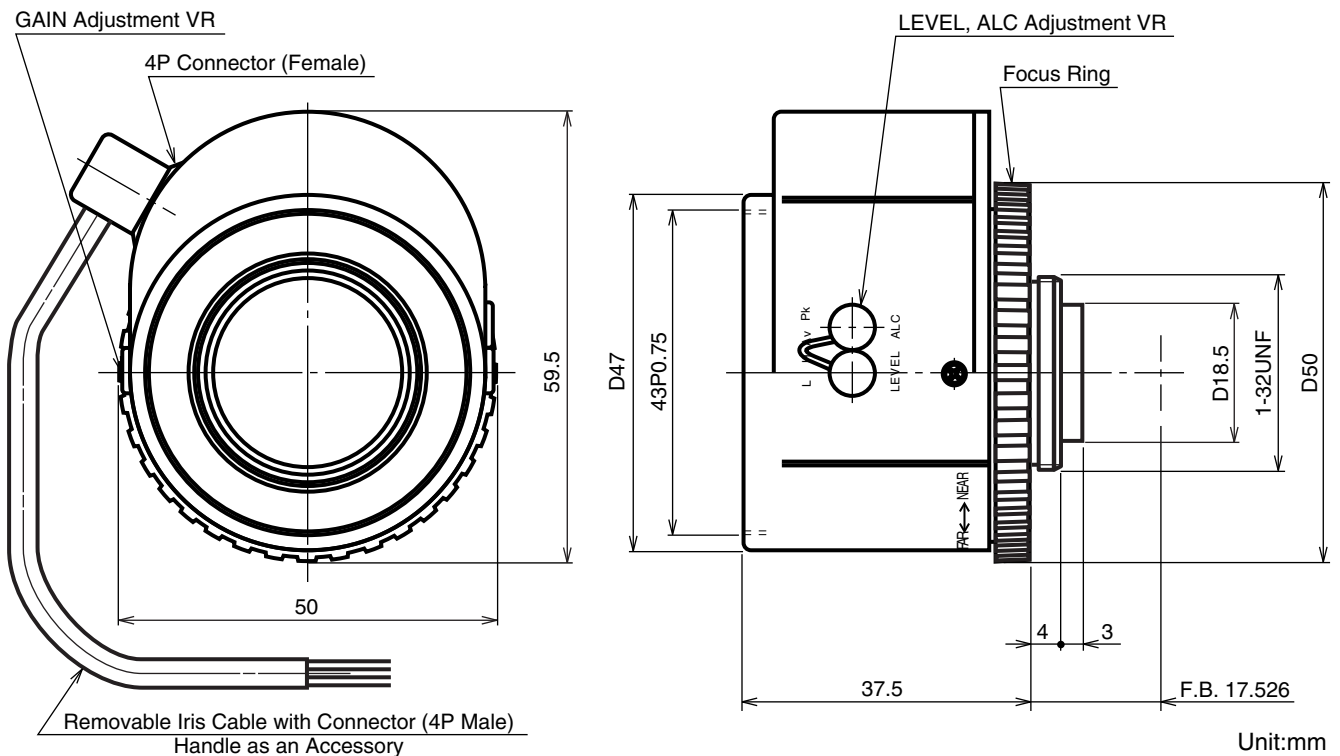

[CIRCUIT DIAGRAM]

