

JF4.8M

Image Size: $\frac{2}{3}$ $\frac{1}{2}$ $\frac{1}{3}$ $\frac{1}{4}$

[SPECIFICATIONS]

Focal Length :	4.8mm	Flange Back :	17.526mm
Maximum Relative Aperture :	1:1.8	Operation :	Focus : Manual Iris : Manual
Iris :	F1.8 - Close	Operation Temperature :	-10 to +50
Angular Field of View :	85.0 X69.0 deg.	Mount :	C-Mount
Image Format :	8.8X6.6mm(D11mm)	Front Thread :	37.5mm P0.5
Minimum Object Distance :	0.2m(From Front Vertex)	Size, Weight :	D42X38.6mm, Approx. 75g
Object Dimensions at M.O.D. :	39.4X29.6cm		
Optical Back Focal Distance :	10.86mm(In Air)		

[COMPOSITION]

- Lens1
- Lens Cap1
- Dust Cap1

[DIMENSIONS]

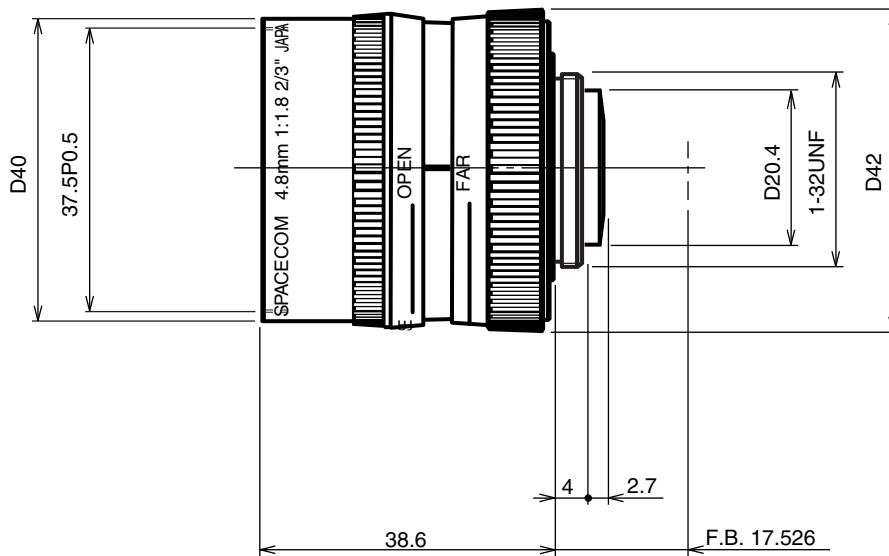

Unit:mm